

WM343-CS332-Q370

WM343-CS332-C246

8th/9th Gen Intel® Core™
Desktop Box IPC



KEY FEATURES



Upgraded CPU

Powered by 8th/9th Gen Intel® Core™



Triple Independent Display

VGA + 2 DP++

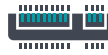

4 Expansion Slots

3.5"/2.5" SATA + 5.25" optical drive bay

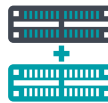

Multiple Expansion

Support 1 PCIe x16, 2 PCIe x4, 1 PCI, 1 M.2 2280, 1 M.2 2230



15 Years Long Term Support

15-Year CPU Life Cycle Support Until Q3' 33



PANEL

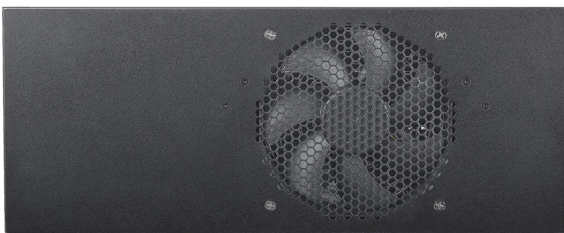

Front View

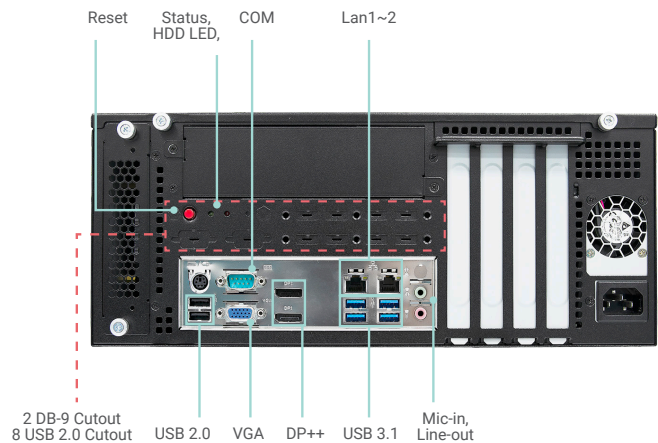

Rear View

DIMENSIONS

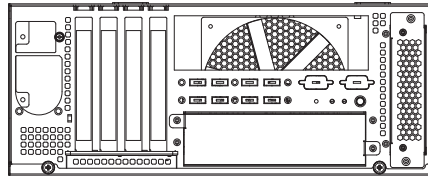

Rear View

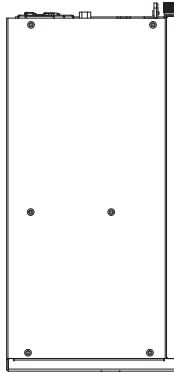

Left View

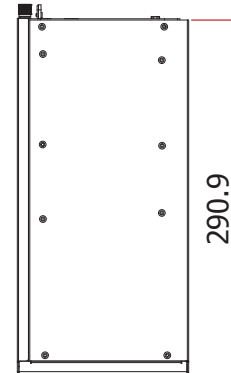
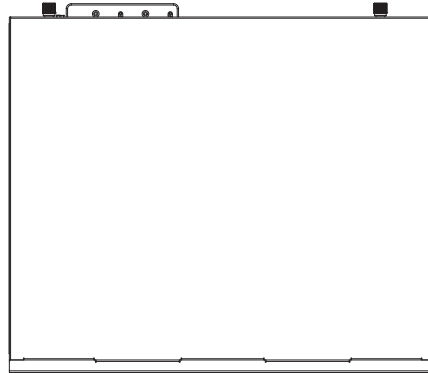

Right View

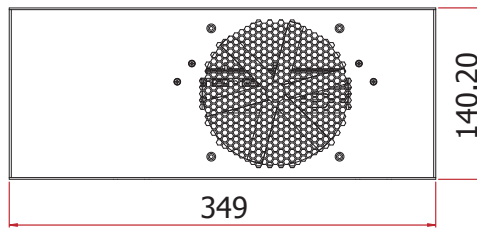

Front View

WALL MOUNTING

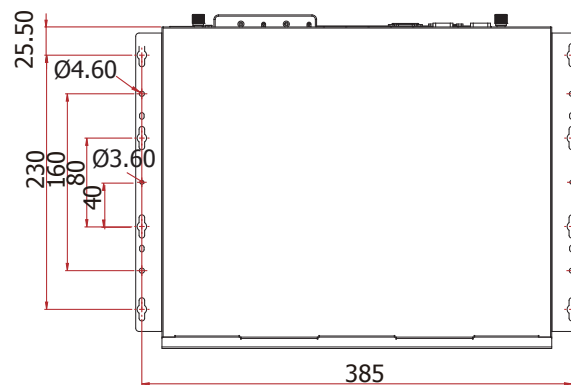
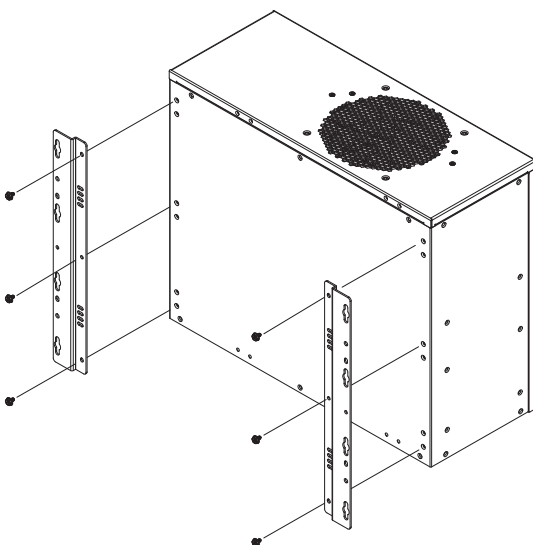

SPECIFICATION

Model Name		WM343-CS332-Q370	WM343-CS332-C246
SYSTEM	Processor	8th Generation Intel® Core™ /Pentium®/Celeron® LGA 1151 Socket Processors: Intel® Xeon® E-2176G (6 Cores, 12M Cache, up to 4.7 GHz); 80W (C246 only) Intel® Xeon® E-2124G (4 Cores, 8M Cache, up to 4.5 GHz); 71W (C246 only) Intel® Core™ i7-8700K (6 Cores, 12M Cache, up to 4.7 GHz); 95W Intel® Core™ i7-8700 (6 Cores, 12M Cache, up to 4.6 GHz); 65W Intel® Core™ i7-8700T (6 Cores, 12M Cache, up to 4.0 GHz); 35W Intel® Core™ i5-8500 (6 Cores, 9M Cache, up to 4.1 GHz); 65W Intel® Core™ i5-8500T (6 Cores, 9M Cache, up to 3.5 GHz); 35W Intel® Core™ i3-8100 (4 Cores, 6M Cache, 3.6 GHz); 65W Intel® Core™ i3-8100T (4 Cores, 6M Cache, to 3.1 GHz); 35W Intel® Pentium® G5400 (2 Cores, 4M Cache, 3.7 GHz); 58W Intel® Pentium® G5400T (2 Cores, 4M Cache, 3.1 GHz); 35W Intel® Celeron® G4900 (2 Cores, 2M Cache, 3.1 GHz); 54W Intel® Celeron® G4900T (2 Cores, 2M Cache, 2.9 GHz); 35W 9th Generation Intel® Core™ LGA 1151 Socket Processors: Intel® Xeon® E-2278GE (8 Cores, 16M Cache, up to 4.7 GHz); 80W (C246 only) Intel® Xeon® E-2278GEL (8 Cores, 16M Cache, up to 3.9 GHz); 35W (C246 only) Intel® Xeon® E-2226GE (6 Cores, 12M Cache, up to 4.6 GHz); 80W (C246 only) Intel® Core™ i9-9900K (8 Cores, 16M Cache, up to 5.0 GHz); 95W (Non-LTS) Intel® Core™ i7-9700TE (8 Cores, 12M Cache, up to 3.8 GHz); 35W Intel® Core™ i5-9500E (6 Cores, 9M Cache, up to 4.2 GHz); 65W Intel® Core™ i5-9500TE (6 Cores, 9M Cache, up to 3.6 GHz); 35W Intel® Core™ i3-9100E (4 Cores, 6M Cache, 3.7 GHz); 65W Intel® Core™ i3-9100TE (4 Cores, 6M Cache, to 3.2 GHz); 35W	
	Chipset	Intel® Q370 Chipset	Intel® C246 Chipset
	Memory	Four 288-pin DIMM up to 128GB Dual Channel DDR4 2400/2666 MHz	Two 288-pin DIMM up to 64GB Dual Channel DDR4 2400/2666 MHz
	BIOS	AMI SPI 128Mbit	AMI SPI 128Mbit
	GRAPHICS	Controller	Intel® HD Gen 9 Graphics
GRAPHICS	Feature	OpenGL 5.0, DirectX 12, OpenCL 2.1 HW Decode: AVC/H.264, MPEG2, VC1/WMV9, JPEG/MJPEG, HEVC/H265, VP8, VP9 HW Encode: MPEG2, AVC/H264, JPEG, HEVC/H265, VP8, VP9	OpenGL 5.0, DirectX 12, OpenCL 2.1 HW Decode: AVC/H.264, MPEG2, VC1/WMV9, JPEG/MJPEG, HEVC/H265, VP8, VP9 HW Encode: MPEG2, AVC/H264, JPEG, HEVC/H265, VP8, VP9
	Display	1 x VGA 2 x DP++ VGA: resolution up to 1920x1200@60Hz DP++: resolution up to 4096x2106@60Hz	1 x VGA 2 x DP++ VGA: resolution up to 1920x1200@60Hz DP++: resolution up to 4096x2106@60Hz
	Triple Displays	VGA + 2 DP++	VGA + 2 DP++
	STORAGE	External	1 or 2 x 3.5"/2.5" SATA 3.0 Drive Bays (1 x 3.5" SATA drive bay, by default) 1 x 5.25" Optical Drive Bay
STORAGE	Internal	1 x M.2 2280 (PCIe x4/SATA)	
	Interface	1 x PCIe x16 (Gen 3) 2 x PCIe x4 (Gen 3) 1 x PCI 1 x M.2 2242/2280 M key (PCIe Gen3 x 4 NVMe /Intel Optane Memory Support) 1 x M.2 2230 E key (PCIe x1/USB2.0)	1 x PCIe x16 (Gen 3) 2 x PCIe x4 (Gen 3) 1 x PCI 1 x M.2 2242/2280 M key (PCIe Gen3 x 4 NVMe /Intel Optane Memory Support) 1 x M.2 2230 E key (PCIe x1/USB2.0)
	AUDIO	Audio Codec	Realtek ALC262-VC2
AUDIO	Interface	1 x Line-out 1 x Mic-in 1 x Line-in (opt.)	
	ETHERNET	Controller	1 x Intel® i219LM PCIe (10/100/1000Mbps) (only Xeon, Core i7/i5 support iAMT) 1 x Intel® i211AT PCIe (10/100/1000Mbps) 2 x Intel® i211AT PCIe (10/100/1000Mbps) (opt. by request, MOQ required)
ETHERNET	Controller	1 x Intel® i219LM PCIe (10/100/1000Mbps) (only Xeon, Core i7/i5 support iAMT) 1 x Intel® i211AT PCIe (10/100/1000Mbps) 2 x Intel® i211AT PCIe (10/100/1000Mbps) (opt. by request, MOQ required)	
	LED	Indicators	1 x Power LED 1 x HDD LED
REAR I/O	Ethernet	2 x GbE (RJ-45) or 4 x GbE (RJ-45) (based on different configuration)	
	Serial	1 x RS-232/422/485 (RS-232 w/ power) (DB-9)	
	USB	4 x USB 3.1 Gen 1 2 x USB 2.0	
	Display	1 x VGA 2 x DP++	
	Audio	1 x Line-out 1 x Mic-in 1 x Line-in (opt.)	
	PS/2	1 x PS/2 (mini-DIN-6)	

SPECIFICATION

Model Name		WM343-CS332-Q370	WM343-CS332-C246
REAR I/O	Buttons	1 x Power button 1 x Reset button	1 x Power button 1 x Reset button
	Cutout	2 x DB-9 Cutout 8 x USB 2.0 Cutout	2 x DB-9 Cutout 8 x USB 2.0 Cutout
WATCHDOG TIMER	Output & Interval	System Reset, Programmable via Software from 1 to 255 Seconds	System Reset, Programmable via Software from 1 to 255 Seconds
SECURITY	TPM	Infineon TPM1.2/2.0 (optional)	Infineon TPM1.2/2.0 (optional)
POWER	Supply	Flex ATX 150W/250W/350W/400W/500W (250W Default)	Flex ATX 150W/250W/350W/400W/500W (250W Default)
COOLING	Fan	1 x 12cm system fan	1 x 12cm system fan
OS SUPPORT	Microsoft	Windows 10	Windows 10
	Linux	Linux	Linux
ENVIRONMENT	Operating Temperature	0 to 45°C	0 to 45°C
	Storage Temperature	0 to 60°C	0 to 60°C
	Relative Humidity	5 to 95% RH (non-condensing)	5 to 95% RH (non-condensing)
MECHANICAL	Construction	Sheet Metal	Sheet Metal
	Mounting	Wall mount	Wall mount
	Dimensions (W x H x D)	349 x 140.2 x 290.9mm (13.74" x 5.52" x 11.45")	349 x 140.2 x 290.9mm (13.74" x 5.52" x 11.45")
	Weight	7.7kg	7.7kg
	Color	no coating or black coating	no coating or black coating
STANDARDS AND CERTIFICATIONS	Shock	Operating: 3G Non-operating: 5G	Operating: 3G Non-operating: 5G
	Vibration	Operating: Random 5~500Hz 0.5G Non-operating: Sine 10~500Hz 1.5G	Operating: Random 5~500Hz 0.5G Non-operating: Sine 10~500Hz 1.5G
	Package Drop	ISTA Project 1A	ISTA Project 1A
	Certification	CE, FCC Class A, RoHS	CE, FCC Class A, RoHS

ORDERING INFORMATION

Model Name	Part Number	Description
WM343-CS332	750-WM3437-000G	WM343-CS, uATX System, Black, CS332-C246, 250W, F/G SYSTEM RoHS
WM343-CS332	750-WM3437-100G	WM343-CS, uATX System, Black, CS332-Q370, 250W, F/G SYSTEM RoHS

OPTIONAL ITEMS

Optional Items	Part Number	Description
Wall Mount	761-WM3410-000G	ACCESSORY WALL MOUNT KITS WM34x Series RoHS

PACKING LIST

• 1 WM343-CS332 System Unit
• 1 CPU cooler
• 1 SATA Data Cable (Length: 650mm)
• 4 HDD Screws
• 1 Quick Installation Guide
• 1 PSU Flex ATX 150W/250W/350W/400W/500W (250W Default)
• 1 System Fan